

# Maniglia porte passeggeri - Passengers' door handle





## P.203

-  **Materiale - Material**  
Poliammide fibra vetro + anti-UV  
Glass fibre polyamide + anti-UV
-  **Colore - Colour**  
Nero - Black
-  **Pezzi confezione - Package items**  
10 pezzi - pieces
-  **Volume confezione - Package volume**  
12,7 dm<sup>3</sup>
-  **Peso confezione - Package weight**  
P.203 m, m/ra = 2.850 g  
P.203 mJ1, mJ2, m/ra J1, m/ra J2 = 2.550 g

**SPO** **Ricambi - Spare parts only**  
vedi sez. tecnica - see technical section









 **Accessori - Accessories**  
vedi sez. tecnica - see technical section



 **Carico di rottura a 20°C - Breakup load at 20°C**  
-

 **Temp. di esercizio - Working temp.**  
-10/+120 °C

**LEX** **Normative - Norms**  
R107.8; R118.3; FMVSS 302; ISO 3795; REACH; ROHS; CMR.  
More info on page A4-A5 and website on "Directives and regulations" area.



| P.203   |       | m manual  |  |
|---|-------|---|--|
|  | Cod.  |   |  |
| A1 - 137  | 67777 |   |  |
| A2 - 146  | 67767 |   |  |
| A3 - 150  | 67787 |   |  |
| A4 - 124  | 67797 |   |  |
| A5 - 501  | 67807 |   |  |
| A6 - 502  | 67817 |   |  |
| A7 - 250  | 67827 |   |  |
| A8 - 262  | 67837 |   |  |
| A9 - 269  | 67867 |   |  |
| A10 - 278   | 67857 |   |  |
| A11/A19   |       |  |  |
| A20 - 510   | 63501 |   |  |
| A21 - 511   |       |  |  |
| A22 - 512   | 63481 |   |  |
| A23 - 513   | 60801 |   |  |
| A24 - 514   |       |  |  |
| A25 - 515   | 62271 |   |  |
| A26 - 516   | 63021 |   |  |
| A27 - 517   |       |  |  |
| A28 - 518   |       |  |  |
| A29 - 519   |       |  |  |
| A30 - 520   | 63321 |   |  |
| PS200   | 63011 |   |  |
| J1  | 66059 |  |  |
| J2  | 67449 |  |  |

| P.203   |       | manuale con ritorno autom. pomello interno<br>manual with automatic return of doorknob |  |
|---|-------|--|--|
|  | Cod.  |  |  |
| PS200   | 65951 |  |  |
| J1  | 65931 |     |  |
| J2  | 65941 |     |  |

 **+1** versione con serratura, chiave rimovibile con maniglia chiusa  
version with lock, removable key with locked handle

J1-J2 Sez. Tecnica (inserimento P.474) - Technical section (assembly P.474)

 versione a richiesta - version available on request

## P.203

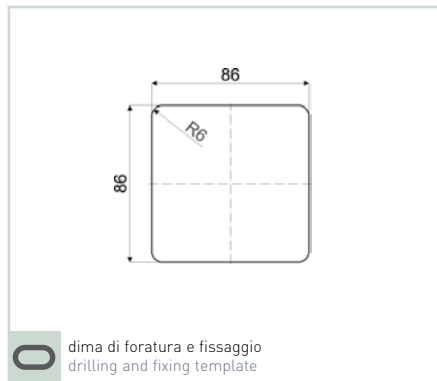
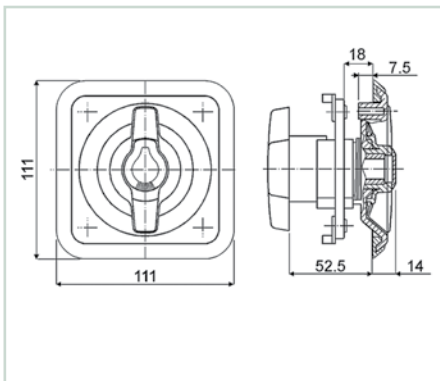

**O** dima di foratura e fissaggio  
drilling and fixing template

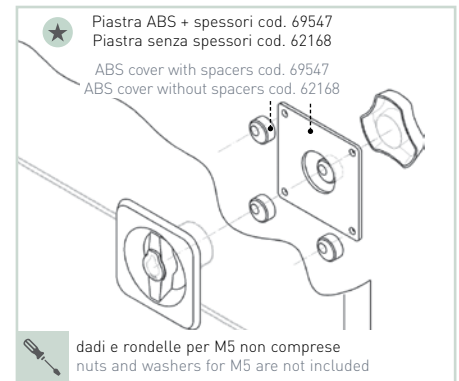

### ■ Inserimento - Assembly P.474 for J1

- 1 Verificare corretta posizione nerva (verticale)
- 1\* Se non OK, ruotare in senso anti-orario il "quadro" sul fondo dello statore sino a fine corsa
- 2 Inserire la serratura con la lamella rivolta verso lo scivolo (ulteriori info pag.A3), previo ingrassaggio preleminare - Chiave removibile solo con maniglia chiusa

- 1 Check if bar is in "vertical" position
- 1\* If not, turn the "square" at the bottom of the stator, anti-clockwise until it rest
- 2 Insert the lock as shown with the fin facing the chute (more info page A3), after preliminary greasing - Removable key with locked handle

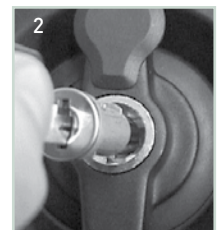
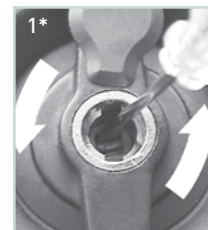
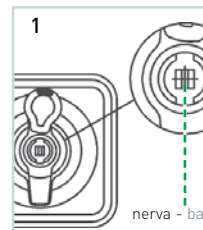

### ■ Inserimento - Assembly P.474 for J2

- 3 Verificare corretta posizione nerva (orizzontale)
- 3\* Se non OK, ruotare in senso orario il "quadro" sul fondo dello statore sino a fine corsa
- 4 Inserire la serratura con la lamella rivolta verso lo scivolo (ulteriori info pag.A3), previo ingrassaggio preleminare - Chiave removibile solo con maniglia chiusa

- 3 Check if bar is in "orizzontal" position
- 3\* If not, turn the "square" at the bottom of the stator, clockwise until it rest
- 4 Insert the lock as shown with the fin facing the chute (more info page A3), after preliminary greasing - Removable key with locked handle

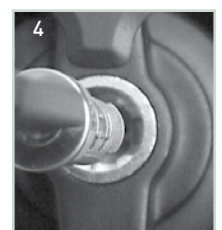
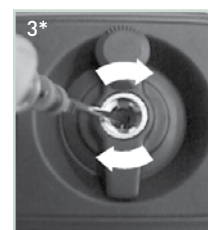
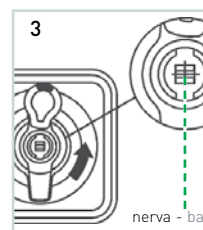

### ■ Esempi d'applicazione - Examples of application

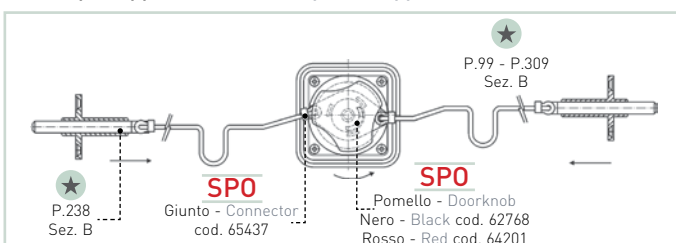

### ■ P.203 m

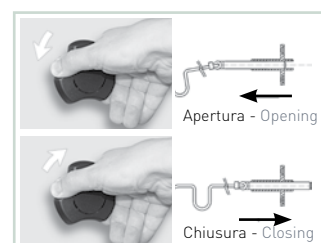

### ■ P.203 (cod. 65931 - 65941 - 65951)

