









-  **Materiale - Material**
Corpo e diffusori aria in ABS,
vetro di protezione luci in policarbonato
Body and air diffuser in ABS,
light protection in polycarbonate
-  **Colore - Color**
grigio - grey Ral 7043
-  **Pezzi confezione - Package items**
10 pezzi - pieces
-  **Volume confezione - Package volume**
64 dm³
-  **Peso confezione - Package weight**
secondo codice - according to item code
-  **Ricambi - Spare parts**
vedi sez. tecnica - see technical section
-  **Accessori - Accessories**
vedi sez. tecnica - see technical section
-  **Sezione utile passaggio aria -**
Open air flow section: 1.900 mm²
-  **Intensità luminosa - Light intensity**
vedi sez. tecnica - see technical section
-  **Temp. di esercizio - Working temp.**
-10/+100 °C
-  **LEX Normative - Norms**
pag. G2



P.389

Cod.	 Incandescent BA 15S							
65799	2 pz. x 24V max 10W	•	*	•	•	17.000	•	50
66459	include - included	•	*	•	•	13,500	•	50

 tipologia di illuminazione - lighting type

 luce blu notturna - blu night light

 interruttore luci - light switch

 *pulsante rosso chiamata hostess - red hostess call push-button

 altoparlante - loudspeaker

 cablaggio - wiring

 materiale disponibile a stock - material available on stock

 materiale non disponibile a stock - material not available on stock

 lotto minimo d'acquisto - minimum purchasing lot

P.389

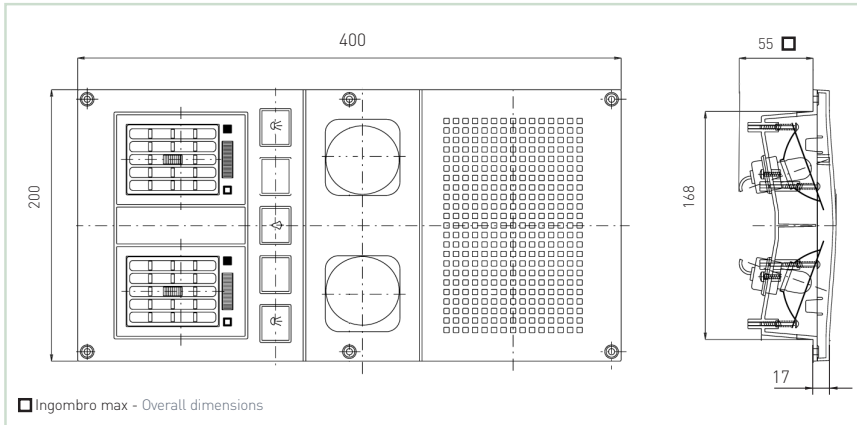

□ Ingombro max - Overall dimensions

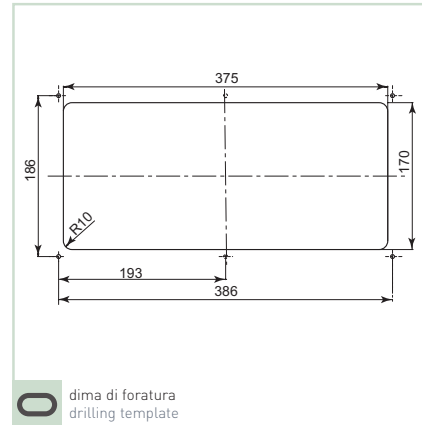

○ dima di foratura
drilling template

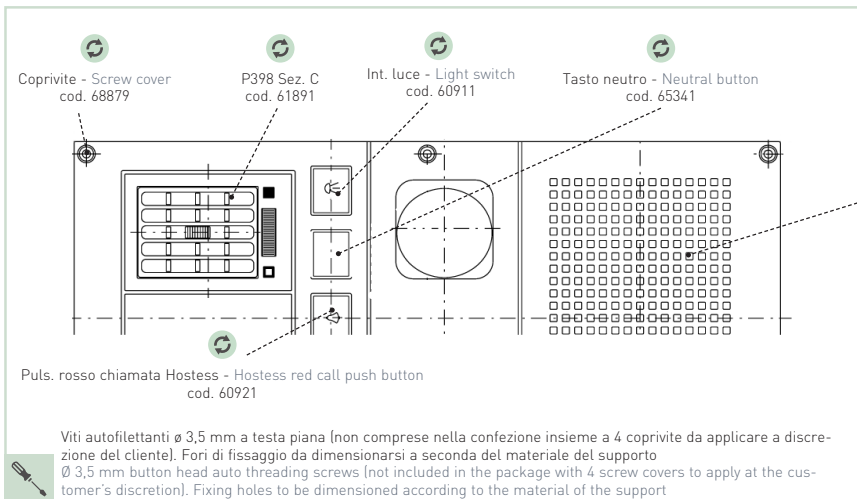

Puls. rosso chiamata Hostess - Hostess red call push button
cod. 60921

Viti autofilettanti \varnothing 3,5 mm a testa piana (non comprese nella confezione insieme a 4 coprivite da applicare a discrezione del cliente). Fori di fissaggio da dimensionarsi a seconda del materiale del supporto \varnothing 3,5 mm button head auto threading screws (not included in the package with 4 screw covers to apply at the customer's discretion). Fixing holes to be dimensioned according to the material of the support

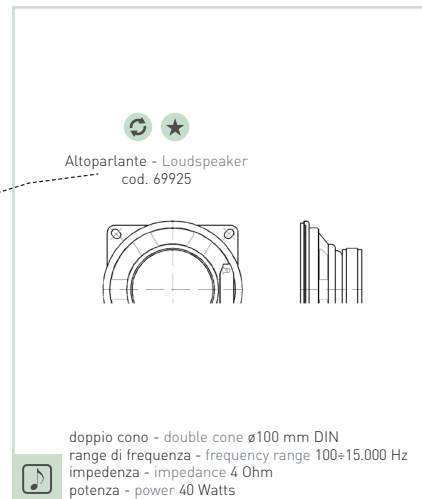

Altoparlante - Loudspeaker
cod. 69925

doppio cono - double cone \varnothing 100 mm DIN
range di frequenza - frequency range 100+15.000 Hz
impedenza - impedance 4 Ohm
potenza - power 40 Watts

■ Test intensità luminosa - Light intensity test

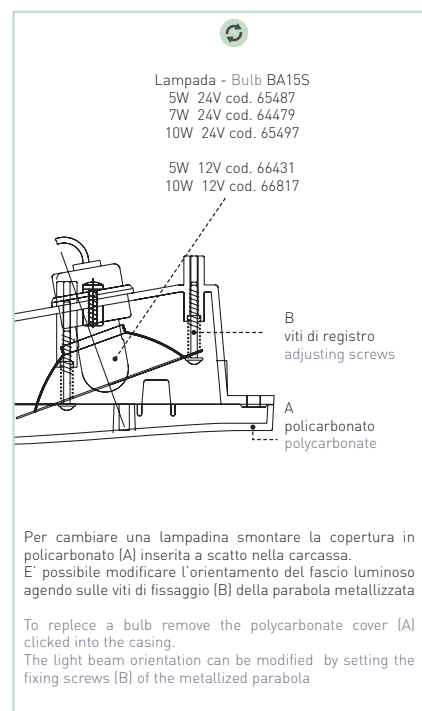
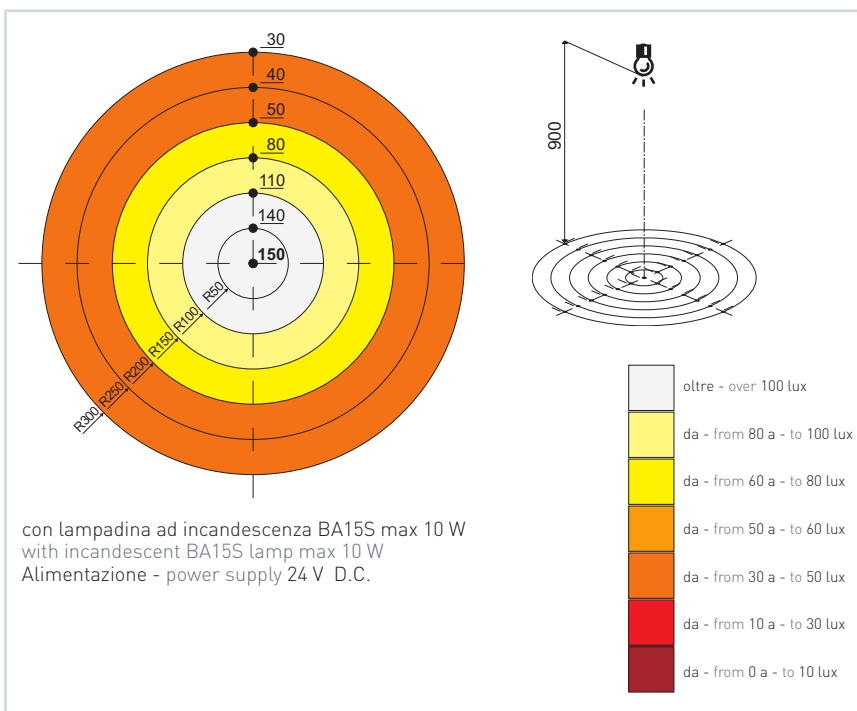

Per cambiare una lampadina smontare la copertura in policarbonato (A) inserita a scatto nella carcassa. E' possibile modificare l'orientamento del fascio luminoso agendo sulle viti di fissaggio (B) della parabola metallizzata

To replace a bulb remove the polycarbonate cover (A) clicked into the casing. The light beam orientation can be modified by setting the fixing screws (B) of the metallized parabola